

Compact Gastronorm Saladettes

With Cutting Board

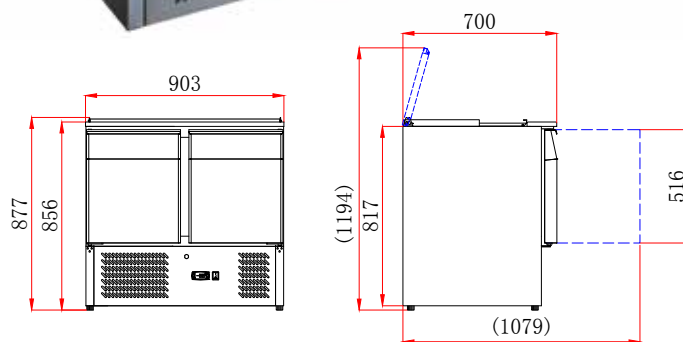
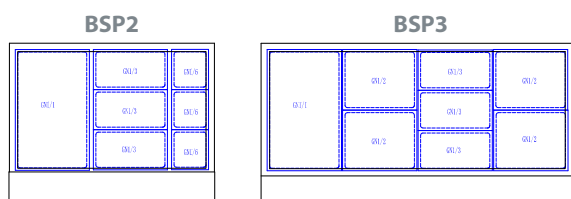
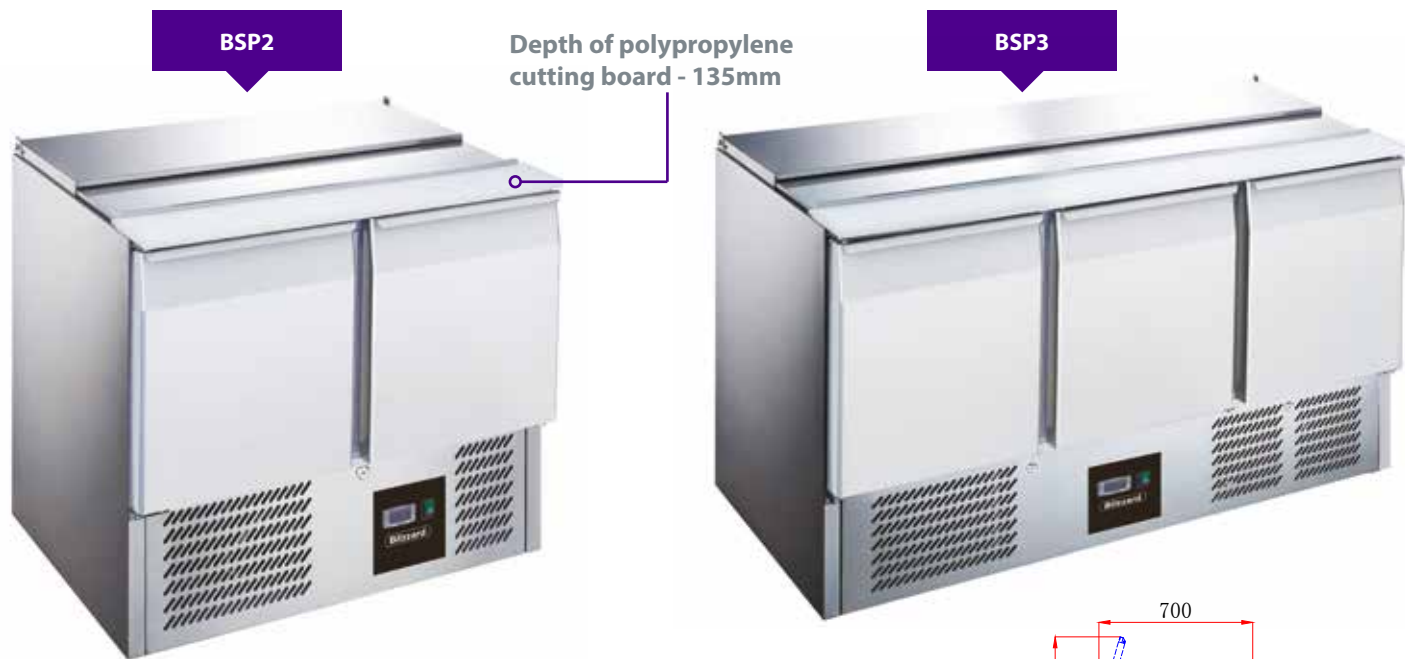

FEATURES

- High grade AISI 304 stainless steel exterior & interior
- Internal corners rounded to aid cleaning
- Self closing doors
- 1 x adjustable GN1/1 shelf per door
- GN sized well accepts containers - max depth 150 mm (containers are not included)
- Hinged lid over GN well
- 135mm deep polypropylene cutting board
- Adjustable feet
- Replaceable door gasket
- 35mm insulation
- Easily removable condenser filter for cleaning

TECHNICAL SPECIFICATIONS

- Controller: Dixell controller
- Cooling: Fan assisted
- Defrost: Automatic
- Refrigerant: R600a (BSP2)
R290 (BSP3)
- Climate Class: 4
- Temperature Range: +2°C ~ +8°C
- Decibels: 42dBA
- Power Supply: 13amp

MODEL	DOOR	CONTAINER CAPACITY	GROSS CAPACITY	EXT. DIMENSIONS (H x W x D mm)	POWER CONSUMPTION	WEIGHT (kg)	RRP
BSP2	2	2 x GN1/1 + 3 x GN1/6	240L	877 x 903 x 700	170W	94	
BSP3	3	4 x GN1/1	368L	877 x 1368 x 700	240W	103	



See page 9 for full GN container range

