



P6P5 - Lincat Panther 670 Series Free-standing Hot Cupboard - Plain Top - W 1855 mm - 2.5 kW

A great solution for holding and transporting food at the perfect temperature, the Panther 670 Series Hot Cupboard is designed to fit through narrow doorways, so is ideal for pubs and smaller restaurants as well as nursing and care homes where plated meals are to be transported from the kitchen to the residents.

- ✔ 670mm depth allows access through narrow door openings also ideal to fit through narrow corridors
- ✔ Ideal for small restaurants, cafes and pubs, as well as nursing and care homes, where the easy transportation of plated meals to diners and residents is a necessity.
- ✔ Fan assisted hot cupboard provides even heat distribution, fast heat up and recovery times, and lower energy usage. Four shelf positions allow adjustment to meet individual needs.
- ✔ Fully 1/1 GN compatible hot cupboard for operational efficiency. Units available to take 5 x 1/1 GN containers up to 150mm deep.
- ✔ Accurate digital electronic control of the hot cupboard temperature, adjustable between 20 and 99 °C, ensures compliance with food hygiene regulations
- ✔ Double skinned construction provides efficient heat retention and a cool to touch exterior - safe and energy efficient. Removable doors and shelves allow access to the fully stainless steel interior for easy cleaning
- ✔ Supplied with two heavy duty multi-section chrome plated rod shelves capable of taking the heaviest loads

**Specifications**

Summary		Power and Performance	
<b>Brand</b>	Lincat	<b>Total Power kW</b>	2.50
<b>Range</b>	Panther	<b>Temperature Range °C</b>	20-99
<b>Series</b>	670 Series	<b>IP Rating</b>	IP24
<b>Power Type</b>	Electric	<b>Temperature Control</b>	Electronic
<b>Unit Type</b>	Free-standing		
<b>Available in UK Only</b>	No		
<b>UK Warranty</b>	2 Years Parts and Labour Warranty		
<b>Export Warranty</b>	Contact your local dealer		
<b>GTIN</b>	5056105103462		

Key Specifications		Capacity	
<b>Number of Shelves included</b>	2	<b>Plate Capacity</b>	476
<b>Number of Shelf Positions</b>	4		
<b>Heated Base</b>	Yes		
<b>Heated Gantry</b>	No		
<b>Static or Mobile</b>	Mobile		

**Weights and Dimensions** **Supply Connections**

<b>Unit Height (External) mm</b>	900
<b>Unit Width (External) mm</b>	1855
<b>Unit Depth (External) mm</b>	670
<b>Height (Internal) mm</b>	432
<b>Width (Internal) mm</b>	1,670
<b>Depth (Internal) mm</b>	512
<b>Shelf Dimensions Width mm</b>	1,610
<b>Shelf Dimensions Depth mm</b>	512
<b>Net Weight Kg</b>	124.5

<b>Requires Installation</b>	No
<b>Requires Electrical Supply</b>	Yes
<b>UK 3 Pin Plug</b>	Yes
<b>Requires Hardwiring</b>	No
<b>Electrical Supply Rating Watts</b>	2,500
<b>Single Phase Amps</b>	10.9
<b>Single Phase Voltage</b>	230

**Shipping**

<b>Packed Weight Kg</b>	136.95
<b>Packed Height cm</b>	110
<b>Packed Width cm</b>	188
<b>Packed Depth cm</b>	90

**Available Options**

**Overshelf or Gantry**

<b>PG5A</b>	PG5A - Ambient Gantry
<b>PG5H</b>	PG5H - Heated Gantry
<b>PS5A1</b>	PS5A1 - 1 Ambient Overshelf
<b>PS5A2</b>	PS5A2 - 2 Ambient Overshelves
<b>PS5A3</b>	PS5A3 - 3 Ambient Overshelves
<b>PS5H1</b>	PS5H1 - 1 Heated Overshelf
<b>PS5H2</b>	PS5H2 - 2 Heated Overshelves
<b>PS5H3</b>	PS5H3 - 3 Heated Overshelves

**Door Locks**

<b>PDL5</b>	PDL5 - Lockable Door
-------------	----------------------

**Corner Guards**

<b>PCG</b>	PCG - Corner Guards[Set of Four]
------------	----------------------------------

**Trayslides**

<b>PTS5</b>	PTS5 - Tray Slide
-------------	-------------------

**Legs/Castors**

<b>PLK</b>	PLK - Legs[non chargeable]
------------	----------------------------

**Available Accessories**

<b>PLK/S</b>	PLK/S - LEG KIT [FOR CONVERSION IN THE FIELD]
<b>PPB6</b>	PPB6 - ADDITIONAL PUSHBAR

**Technical Picture**

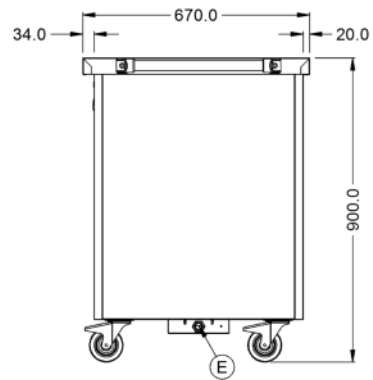
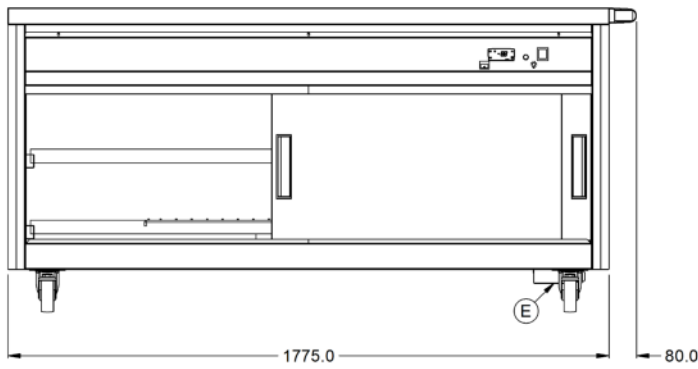

**Lincat Limited**

Whisby Road,  
Lincoln, LN6 3QZ,  
United Kingdom

**Company No:** 2175448

A member company of



**Customer Care**

**Tel:** +44 1522 875500  
**Email:** care@lincat.co.uk

**Export Customers**

**Tel:** +44 1522 875536  
**Email:** export@lincat.co.uk

**Opening Hours**

**Monday – Friday:**  
8.30am – 5pm