



P6B2 - Lincat Panther
670 Series Free-standing
Hot Cupboard - Bain
Marie Top - 2GN - W 980
mm - 2.6 kW

A great solution for holding and transporting food at the perfect temperature, the Panther 670 Series Hot Cupboard / Bain Marie is designed to fit through narrow doorways, so is ideal for pubs and smaller restaurants as well as nursing and care homes where plated meals are to be transported from the kitchen to the residents.

- ✓ Ideal to fit through narrow corridors and doorways
- ✓ Bain marie top, ideal for small restaurants, cafes and pubs, as well as nursing and care homes, where the easy transportation of plated meals to diners and residents is a necessity
- ✓ Fan assisted hot cupboard provides even heat distribution, fast heat up and recovery times, and lower energy usage. Four shelf positions allow adjustment to meet individual needs.
- ✓ Fully 1/1 GN compatible hot cupboard for operational efficiency. Units available to take 2 x 1/1 GN containers up to 150mm deep.
- ✓ Thermostatically controlled bain marie top can be operated with wet or dry heat. Accurate digital electronic control of the hot cupboard temperature, adjustable between 20 and 99 °C, ensures compliance with food hygiene regulations
- ✓ Double skinned construction provides efficient heat retention and a cool to touch exterior - safe and energy efficient. Removable doors and shelves allow access to the fully stainless steel interior for easy cleaning
- ✓ Supplied with two heavy duty multi-section chrome plated rod shelves capable of taking the heaviest loads
- ✓ Drain tap located inside the hot cupboard allows fast and easy draining

Specifications

Summary		Power and Performance	
Brand	Lincat	Total Power kW	2.60
Range	Panther	Temperature Range °C	20-99
Series	670 Series	IP Rating	IP24
Power Type	Electric	Temperature Control	Top: Mechanical; Bottom: Electronic
Unit Type	Free-standing		
Available in UK Only	No		
UK Warranty	2 Years Parts and Labour Warranty		
Export Warranty	Contact your local dealer		
GTIN	5056105103394		

Key Specifications		Capacity	
Drain Location	Right side interior mounted	Gastronorm Capacity	2 x GN1/1
Number of Shelves included	2	Plate Capacity	222
Number of Shelf Positions	4		
Pot Type	Gastronorm		
Type of Heat	Wet/Dry		
Heated Base	Yes		
Heated Gantry	No		
Static or Mobile	Mobile		

Weights and Dimensions **Supply Connections**

Unit Height (External) mm	912
Unit Width (External) mm	980
Unit Depth (External) mm	672
Height (Internal) mm	432
Width (Internal) mm	795
Depth (Internal) mm	512
Shelf Dimensions Width mm	785
Shelf Dimensions Depth mm	512
Net Weight Kg	80.9

Requires Installation	No
Requires Electrical Supply	Yes
UK 3 Pin Plug	Yes
Requires Hardwiring	No
Electrical Supply Rating Watts	2,600
Single Phase Amps	11.3
Single Phase Voltage	230

Shipping

Packed Weight Kg	88.99
Packed Height cm	105
Packed Width cm	100
Packed Depth cm	80

Available Options

Overshelf or Gantry

PG2A	PG2A - Ambient Gantry
PG2H	PG2H - Heated Gantry
PS2A1	PS2A1 - 1 Ambient Overshelf
PS2A2	PS2A2 - 2 Ambient Overshelves
PS2A3	PS2A3 - 3 Ambient Overshelves
PS2H1	PS2H1 - 1 Heated Overshelf
PS2H2	PS2H2 - 2 Heated Overshelves
PS2H3	PS2H3 - 3 Heated Overshelves

Door Locks

PDL2	PDL2 - Lockable Door
-------------	----------------------

Corner Guards

PCG	PCG - Corner Guards[Set of Four]
------------	----------------------------------

Trayslides

PTS2	PTS2 - Tray Slide
-------------	-------------------

Legs/Castors

PLK	PLK - Legs[non chargeable]
------------	----------------------------

Available Accessories

CP16	CP16 - CARVERY PAD[1/1 GASTRONORM SIZE]
PGK1	PGK1 - GASTRONORM PACK
PGK2	PGK2 - GASTRONORM PACK
PGK3	PGK3 - GASTRONORM PACK
PHTC	PHTC - CERAMIC INSERT [1/1 GASTRONORM SIZE]
PHTG	PHTG - GLASS INSERT [1/1 GASTRONORM SIZE]
PLK/S	PLK/S - LEG KIT [FOR CONVERSION IN THE FIELD]
PPB6	PPB6 - ADDITIONAL PUSHBAR

Technical Picture

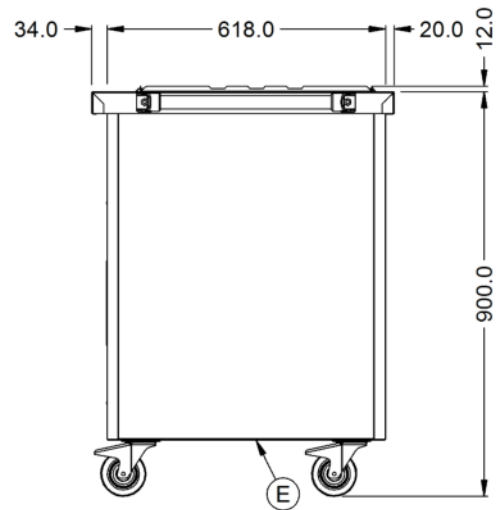
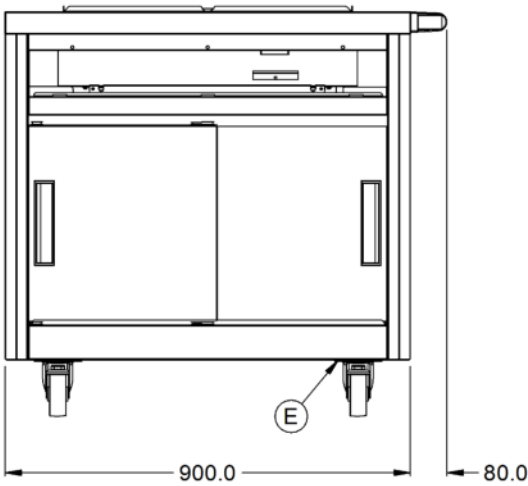
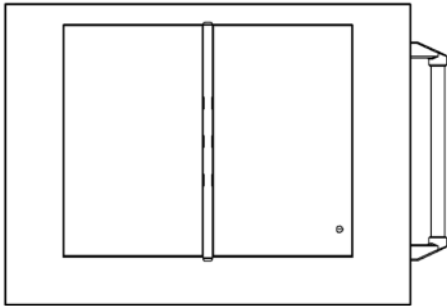

Lincat Limited

Whisby Road,
Lincoln, LN6 3QZ,
United Kingdom

Company No: 2175448

A member company of



Customer Care

Tel: +44 1522 875500
Email: care@lincat.co.uk

Export Customers

Tel: +44 1522 875536
Email: export@lincat.co.uk

Opening Hours

Monday – Friday:
8.30am – 5pm