



OE8303 - Lincat Opus 800 Electric Counter-top Salamander Grill - W 890 mm - 5.4 kW

A fast-heating Opus 800 Electric Salamander Grill with powerful heating elements together with the versatility that comes with two independently controlled heat zones.

- ✓ Powerful heating elements, for reliability and rapid heat up
- ✓ Maximum versatility with left and right independently controlled heat zones
- ✓ Four shelf positions with horizontal or angled settings
- ✓ GN 1/1 compatible
- ✓ Enamelled front for durability

Specifications

Summary

Brand	Lincat
Range	Opus 800
Power Type	Electric
Unit Type	Counter-top
Available in UK Only	No
UK Warranty	2 Years Parts and Labour Warranty
Export Warranty	Contact your local dealer
GTIN	5056105102618

Power and Performance

Total Power kW	5.4
IP Rating	IP23
Cooking Area (Width x Depth) mm	615 x 360
Temperature Control	Mechanical

Key Specifications

Number of Shelves included	1
Number of Shelf Positions	4
Number of Heat Zones	2

Capacity

Gastronorm Capacity	1 x GN1/1
Product Output per Hour	76 x 225g [8oz] steaks [chilled]

Weights and Dimensions

Unit Height (External) mm	510
Unit Width (External) mm	890
Unit Depth (External) mm	520
Shelf Dimensions Width mm	615
Shelf Dimensions Depth mm	360
Net Weight Kg	59

Supply Connections

Requires Installation	Yes
UK 3 Pin Plug	No
Requires Hardwiring	Yes
Electrical Supply Rating Watts	5,400
Single Phase Amps	23.50
Single Phase Voltage	230
Three Phase Amps	L1=11.8; L2=11.8; L3=N/A
Three Phase Voltage	400

Shipping

Packed Weight Kg	71.5
Packed Height cm	84
Packed Width cm	100
Packed Depth cm	85

Available Accessories

BR10	OG8302 BRANDING GRID
OA8907	Lincat Opus 800 Free-standing Floor Stand with Legs - for units W 800 mm
OA8911	WALL BRACKET OG8302/OE8303
OA8912	Lincat Opus 800 Free-standing Floor Stand with Legs - for units W 900 mm

Available Accessories

OA8918

Lincat Opus 800 Free-standing Bench Stand - for units W 900 mm

Technical Picture

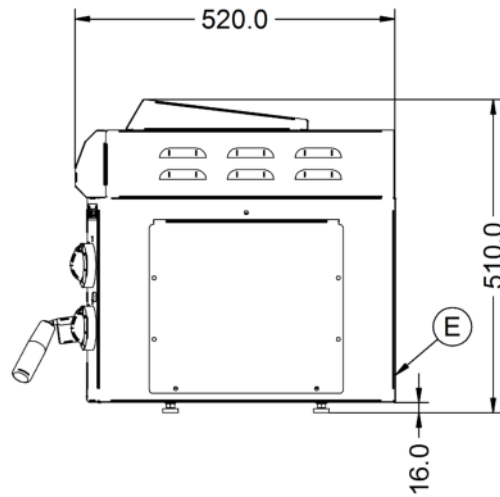
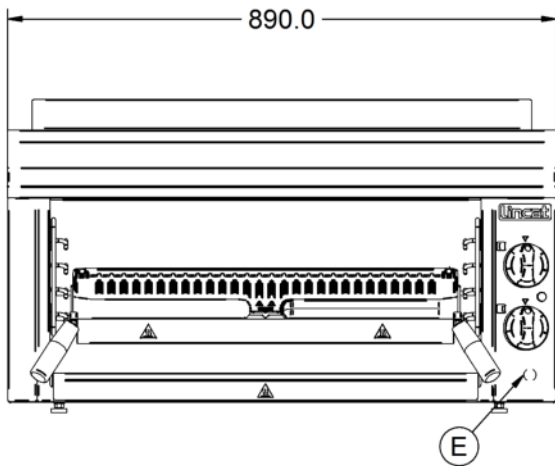
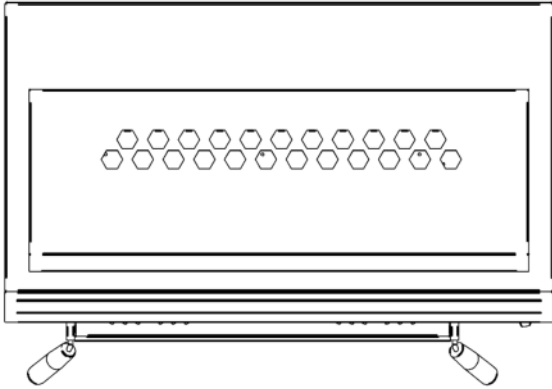



Lincat Limited

Whisby Road,
Lincoln, LN6 3QZ,
United Kingdom

Company No: 2175448

A member company of



Customer Care

Tel: +44 1522 875500
Email: care@lincat.co.uk

Export Customers

Tel: +44 1522 875536
Email: export@lincat.co.uk

Opening Hours

Monday – Friday:
8.30am – 5pm