



OE8211/R - Lincat Opus 800 Electric Counter-top Clam Griddle - Ribbed Upper Plate - W 400 mm - 8.6 kW

Cook flavoursome and succulent food up to three times faster than with a traditional griddle with the Opus 800 Clam Griddle with a ribbed upper plate.

- ✔ Heat from above and below locks in flavour and reduces shrinkage of meat
- ✔ Digital timer on clam plate ensures repeatable results
- ✔ Cook food up to three times as quickly as a standard griddle
- ✔ Precise thermostatic control for consistent results and economical operation

Specifications

Summary

Brand	Lincat
Range	Opus 800
Power Type	Electric
Unit Type	Counter-top
Available in UK Only	No
UK Warranty	2 Years Parts and Labour Warranty
Export Warranty	Contact your local dealer
GTIN	5056105102601

Power and Performance

Total Power kW	8.6
Temperature Range °C	50-250
IP Rating	IP24
Cooking Area (Width x Depth) mm	366 x 525
Temperature Control	Mechanical

Key Specifications

Number of Heat Zones	1
Top Grill Plate Surface Type	Ribbed
Grill Plate Surface Type	1 x Smooth 1 x Ribbed
Grill Plate Material	Aluminium

Capacity

Product Output per Hour	120 x 113g [4oz] burgers [frozen]
--------------------------------	-----------------------------------

Weights and Dimensions

Unit Height (External) mm	542
Unit Width (External) mm	400
Unit Depth (External) mm	800
Net Weight Kg	78.5

Supply Connections

Requires Installation	Yes
Requires Electrical Supply	Yes
UK 3 Pin Plug	No
Requires Hardwiring	Yes
Electrical Supply Rating Watts	8,600
Three Phase Amps	L1=14.0; L2=14.0; L3=9.0
Three Phase Voltage	400

Shipping

Packed Weight Kg	93.5
Packed Height cm	64
Packed Width cm	85
Packed Depth cm	45

Available Accessories

OA8921	Lincat Opus 800 Free-standing Floor Stand with Legs - for units W 400 mm
OA8960	3 POSITION HEIGHT ADJUSTER 10-20-30 - OPUS 800
OA8971	Lincat Opus 800 Free-standing Pedestal with Doors and Legs - for units W 400 mm
TFS01	Teflon Sheet for Clam Griddles [392mm x 500mm]

Technical Picture

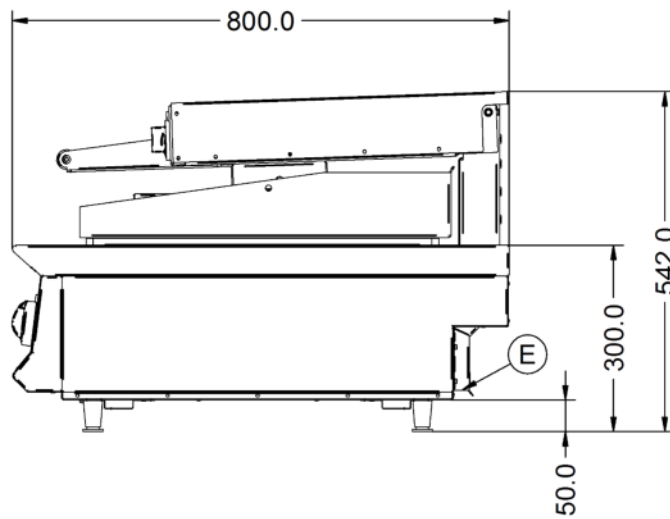
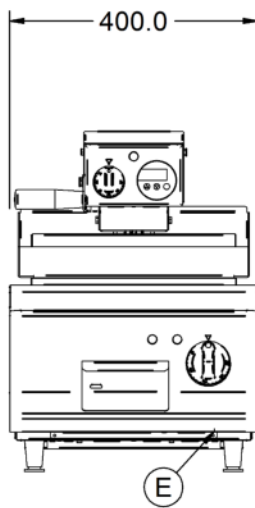
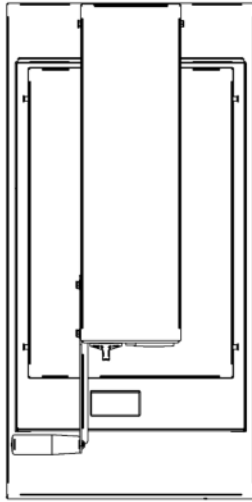

Lincat Limited

Whisby Road,
Lincoln, LN6 3QZ,
United Kingdom

Company No: 2175448

A member company of



Customer Care

Tel: +44 1522 875500
Email: care@lincat.co.uk

Export Customers

Tel: +44 1522 875536
Email: export@lincat.co.uk

Opening Hours

Monday – Friday:
8.30am – 5pm