



OE8008 - Lincat Opus 800 Electric Free-standing Oven Range - W 900 mm - 21.6 kW

The Opus 800 range Electric 6 plate oven combines power with versatility.

- ✓ Powerful heavy-duty cast iron 2.6kW square hotplates deliver fast responsive heat
- ✓ Fully pressed sealed hob for easy cleaning
- ✓ Large 6 x GN1/1 capacity oven enabling six different foods to be cooked simultaneously
- ✓ Electric Oven Ranges

Specifications

Summary

Brand	Lincat
Range	Opus 800
Power Type	Electric
Unit Type	Free-standing
Available in UK Only	No
UK Warranty	2 Years Parts and Labour Warranty
Export Warranty	Contact your local dealer
GTIN	5056105102342

Power and Performance

Total Power kW	21.6
Temperature Range °C	130-250
IP Rating	IP24
Cooking Area (Width x Depth) mm	220 x 220 x 6
Temperature Control	Mechanical
Rating per Hob kW	2.6
Oven Rating kW	6.0

Key Specifications

Number of Shelves included	3
Number of Shelf Positions	5
Number of Hobs	6
Shape of Hob	Square

Capacity

Gastronorm Capacity	6 x GN1/1
----------------------------	-----------

Weights and Dimensions

Unit Height (External) mm	925
Unit Width (External) mm	900
Unit Depth (External) mm	800
Height (Internal) mm	405
Width (Internal) mm	715
Depth (Internal) mm	512
Shelf Dimensions Width mm	710
Shelf Dimensions Depth mm	512
Hob Dimensions mm	220 x 220
Net Weight Kg	138.3

Supply Connections

Requires Installation	Yes
Requires Electrical Supply	Yes
UK 3 Pin Plug	No
Requires Hardwiring	Yes
Electrical Supply Rating Watts	21,600
Three Phase Amps	L1=31.3; L2=31.3; L3=31.3
Three Phase Voltage	400

Shipping

Packed Weight Kg	152
Packed Height cm	104
Packed Width cm	100
Packed Depth cm	85

Available Accessories

LK12	NULL
OA8982	SPLASHBACK/SHELF - OE8008 & OE8016

Technical Picture

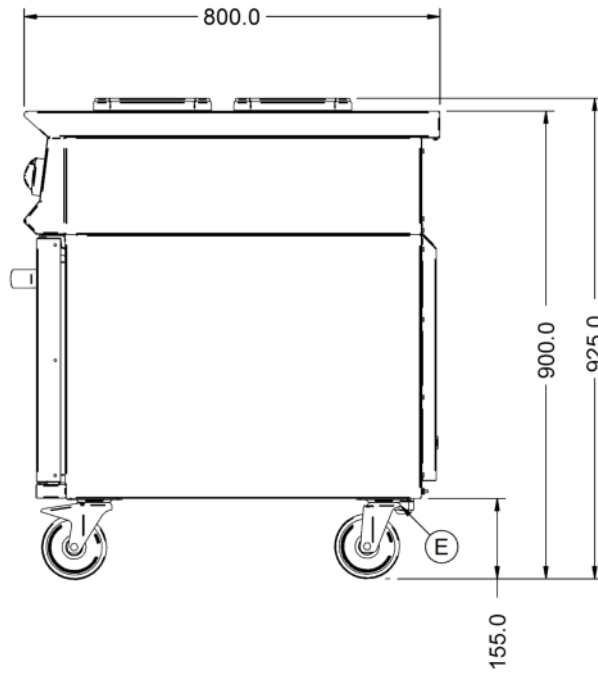
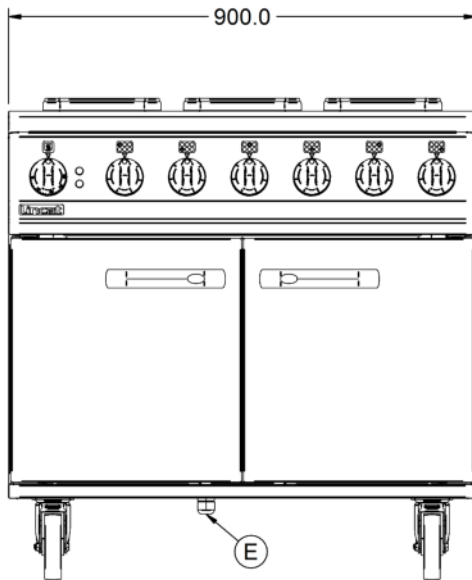
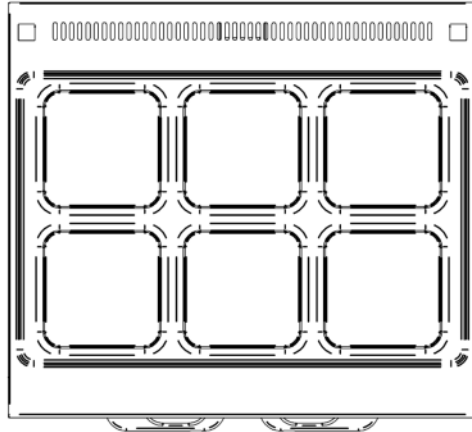

Lincat Limited

Whisby Road,
Lincoln, LN6 3QZ,
United Kingdom

Company No: 2175448

A member company of



Customer Care

Tel: +44 1522 875500
Email: care@lincat.co.uk

Export Customers

Tel: +44 1522 875536
Email: export@lincat.co.uk

Opening Hours

Monday – Friday:
8.30am – 5pm