



OE7505 - Lincat Phoenix Electric Free-standing Atmospheric Steamer - W 630 mm - 9.0 kW

The Phoenix Atmospheric Steamer has a generous capacity of 6 x 1/1GN, which is ideal for steaming vegetables, rice, fish and other foods.

- ✓ Perfect solution for volume production of healthy steamed food
- ✓ Ideal for steaming vegetables, puddings, rice, ham, fish and a range of other foods.
- ✓ Generous capacity 6 x 1/1GN
- ✓ Six shelf positions and removable shelf supports for maximum versatility
- ✓ 304 grade stainless steel oven interior for long service life
- ✓ Thermostatic control and boil dry protection for trouble free operation

Specifications

Summary

Brand	Lincat
Range	Phoenix
Power Type	Electric
Unit Type	Free-standing
Available in UK Only	No
UK Warranty	2 Years Parts and Labour Warranty
Export Warranty	Contact your local dealer
GTIN	5056105109785

Power and Performance

Total Power kW	9
IP Rating	IP24
Temperature Control	Mechanical
Oven Rating kW	9

Key Specifications

Number of Shelves included	6
Number of Shelf Positions	6

Capacity

Gastronorm Capacity	6 x GN1/1
----------------------------	-----------

Weights and Dimensions

Unit Height (External) mm	1620
Unit Width (External) mm	630
Unit Depth (External) mm	820
Height (Internal) mm	680
Width (Internal) mm	520
Depth (Internal) mm	500
Shelf Dimensions Width mm	510
Shelf Dimensions Depth mm	500
Net Weight Kg	110

Supply Connections

Requires Installation	Yes
Requires Electrical Supply	Yes
UK 3 Pin Plug	No
Requires Hardwiring	Yes
Electrical Supply Rating Watts	9,000
Single Phase Amps	39.1
Single Phase Voltage	230
Three Phase Amps	L1=13.0; L2=13.0; L3=13.0
Three Phase Voltage	400
Water Connection Pressure Bar	0.2-10.0
Water Connection	15 mm

Shipping

Packed Weight Kg	122
Packed Height cm	184
Packed Width cm	100
Packed Depth cm	80

Technical Picture

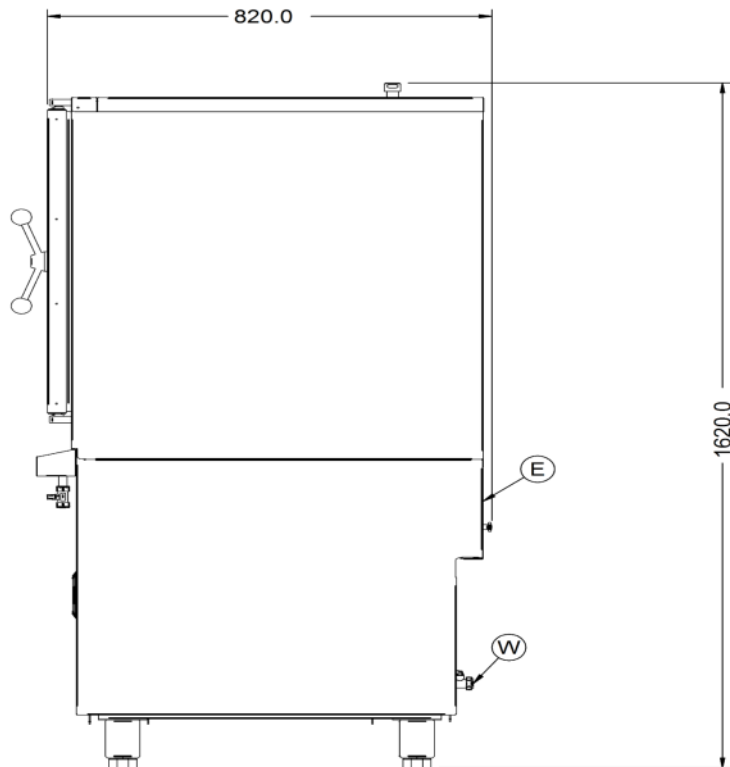
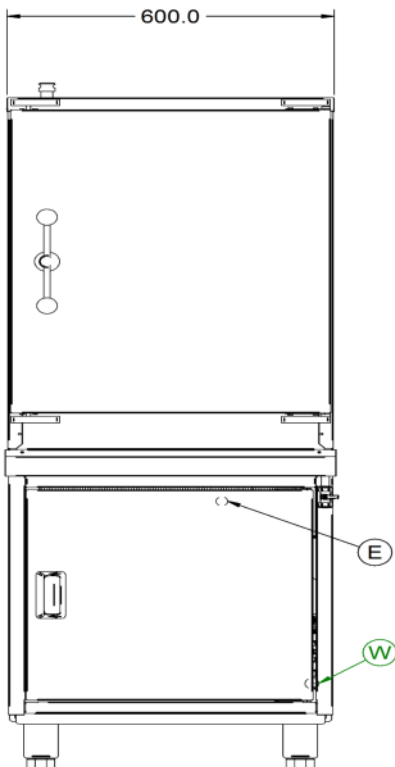
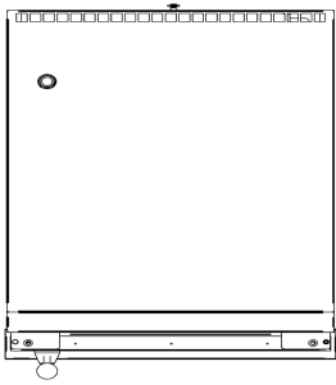

Lincat Limited

Whisby Road,
Lincoln, LN6 3QZ,
United Kingdom

Company No: 2175448

A member company of



Customer Care

Tel: +44 1522 875500
Email: care@lincat.co.uk

Export Customers

Tel: +44 1522 875536
Email: export@lincat.co.uk

Opening Hours

Monday – Friday:
8.30am – 5pm