



F59/820 - IMC SD60 Salad Spinner - W 590 mm - 0.37 kW

Compact and powerful, the SD60 salad spinner washes, dries and mixes fresh salad at speed, enabling kitchens of any size to serve high-quality food quickly.

- ✓ Makes washing, drying and mixing fresh salads quick and easy.
- ✓ Rotates at optimal speed to remove excess water without damaging foods.
- ✓ Compact design and small footprint make it ideal for kitchens of any size.
- ✓ 60-litre volume provides high output.
- ✓ Transparent, heavy-duty lid means progress can be easily monitored.
- ✓ Smooth stainless steel exterior for easy cleaning
- ✓ Holds 4kg to 6kg of leaf-based vegetables.

Specifications

Summary

Brand	IMC
Range	SD Salad Spinner
Power Type	Electric
Unit Type	Free-standing
Available in UK Only	No
UK Warranty	2 Years Parts and Labour Warranty
Export Warranty	Contact your local dealer
GTIN	5056105198925

Power and Performance

Total Power kW	0.37
IP Rating	IP55

Key Specifications

Operator Safety	Interlocks
Drain Location	Rear

Capacity

Capacity Litres	60
------------------------	----

Weights and Dimensions

Unit Height (External) mm	1060
Unit Width (External) mm	482
Unit Depth (External) mm	590
Net Weight Kg	51.5

Supply Connections

Requires Installation	Yes
Requires Electrical Supply	Yes
UK 3 Pin Plug	No
Requires Hardwiring	Yes
Electrical Supply Rating Watts	370
Three Phase Amps	1.2
Three Phase Voltage	400
Water Connection Pressure Bar	2.7-3.8 [40-55 psi]
Drain Connection	54mm
Water Connection	19mm

Shipping

Packed Weight Kg	62.5
Packed Height cm	125
Packed Width cm	50
Packed Depth cm	68

Technical Picture

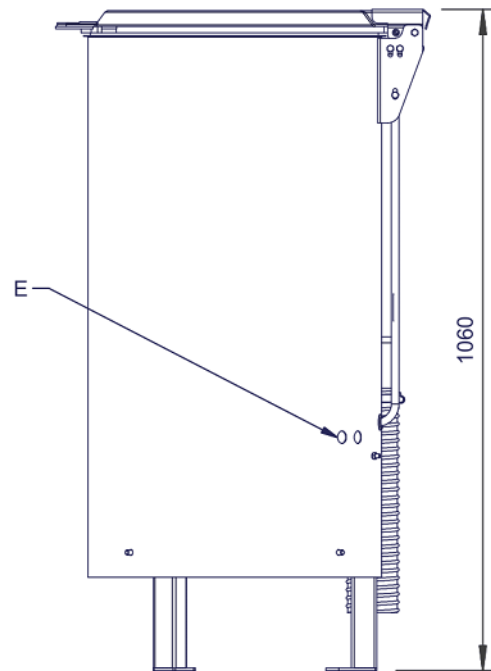
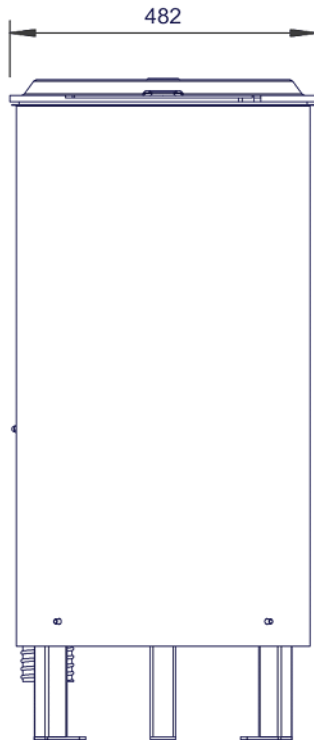
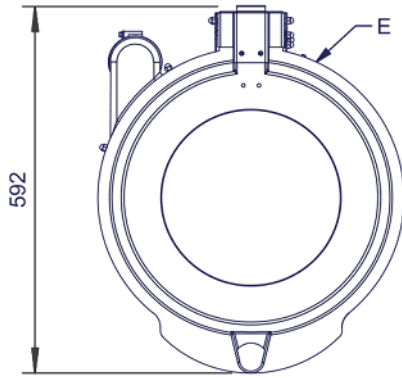

Lincat Limited

Whisby Road,
Lincoln, LN6 3QZ,
United Kingdom

Company No: 2175448

A member company of



Customer Care

Tel: +44 1522 875500
Email: care@lincat.co.uk

Export Customers

Tel: +44 1522 503250
Email: export@lincat.co.uk

Opening Hours

Monday – Friday:
8.30am – 5pm