



LCG2 - Lincat Lynx 400 Electric Counter-top Twin Contact Grill - Smooth Upper & Lower Plates - W 623 mm - 4.5 kW

Heat food rapidly and seal in all the juices and flavour with the Twin-Head 2 x 2.25kW Lynx 400 Electric Contact Grill with smooth plates.

- ✓ Twin head model with smooth plates - ideal where space is limited
- ✓ Fast heat up from cold
- ✓ Enamelled cast iron plates give excellent heat retention and are easy to clean
- ✓ 1 kW element in upper plate and 1.25 kW in lower plate gives balanced cooking - no need to turn food
- ✓ Thermostatic control for accurate repeatable results
- ✓ Ideal for fast cooking of meat products
- ✓ Well balanced, smooth action mechanism with positive "park" position for safe and easy operation
- ✓ Supplied with two cables and two plugs for easy installation

Specifications

Summary

Brand	Lincat
Range	Lynx 400
Power Type	Electric
Unit Type	Counter-top
Available in UK Only	No
UK Warranty	2 Years Parts and Labour Warranty
Export Warranty	Contact your local dealer
GTIN	5056105101130

Power and Performance

Total Power kW	4.50
IP Rating	IP23
Cooking Area (Width x Depth) mm	[2x] 264 x 250
Temperature Control	Mechanical

Key Specifications

Top Grill Plate Surface Type	Smooth
Grill Plate Surface Type	Smooth
Grill Plate Material	Iron

Weights and Dimensions

Unit Height (External) mm	182
Unit Width (External) mm	623
Unit Depth (External) mm	400
Net Weight Kg	38.5

Supply Connections

Requires Installation	No
Requires Electrical Supply	Yes
UK 3 Pin Plug	Yes
Requires Hardwiring	No
Electrical Supply Rating Watts	4,500
Single Phase Amps	19.6
Single Phase Voltage	230

Shipping

Packed Weight Kg	40.5
Packed Height cm	36
Packed Width cm	73
Packed Depth cm	61

Available Accessories

OS2	OMELETTE SPACER - FOR LCG, LCG2, LPG, LPG2, LRG, LRG2
------------	---

Technical Picture

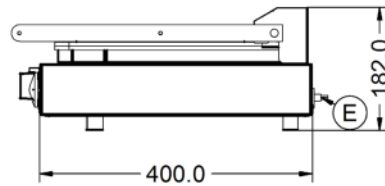
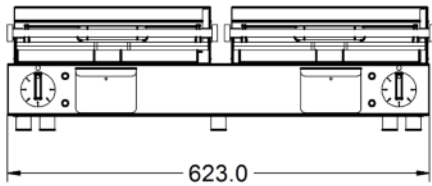
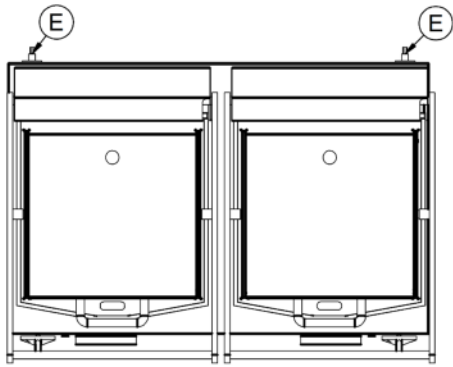

Lincat Limited

Whisby Road,
Lincoln, LN6 3QZ,
United Kingdom

Company No: 2175448

A member company of



Customer Care

Tel: +44 1522 875500
Email: care@lincat.co.uk

Export Customers

Tel: +44 1522 503250
Email: export@lincat.co.uk

Opening Hours

Monday – Friday:
8.30am – 5pm