



F52/301 - IMC Vulture 523 Under-sink Food Waste Disposer - fits 89 mm sink opening - 1 Phase - 0.55 kW

Reliable, efficient, safe and easy to operate, the compact 523 Waste Disposer allows operators to quickly and effectively remove waste, to create a safer and cleaner kitchen.

- ✔ Fast and efficient disposal of up to 100kg of food waste per hour.
- ✔ Comes with rubber housing to minimise noise.
- ✔ Handles up to 200 covers per sitting - ideal for small to medium kitchens.
- ✔ Manually reversible motor to extend operational life.
- ✔ For soft waste (plate waste, vegetables and peelings, meat and fish scraps).
- ✔ Suitable for small to medium kitchens with single-phase power supply.
- ✔ Compact design and under-sink mounting, for quick and easy loading.

Specifications

Summary

Brand	IMC
Range	Vulture
Series	500 Series
Power Type	Electric
Unit Type	Under-sink
Available in UK Only	No
UK Warranty	2 Years Parts and Labour Warranty
Export Warranty	Contact your local dealer
Mounting	Under-sink
GTIN	5056105199663

Power and Performance

Total Power kW	0.55
HP	0.75
IP Rating	IP55

Key Specifications

WRAS Approved	WRAS Compliant
----------------------	----------------

Capacity

Type of Waste	Soft waste
Covers Per Sitting	200
Capacity Kg per Hour	100

Weights and Dimensions

Unit Height (External) mm	420
Unit Width (External) mm	240
Unit Depth (External) mm	219
Net Weight Kg	15.5

Supply Connections

Requires Installation	Yes
Requires Electrical Supply	Yes
UK 3 Pin Plug	No
Requires Hardwiring	Yes
Electrical Supply Rating Watts	550
Single Phase Amps	5.2
Single Phase Voltage	230
Water Supplied From	Sink tap
Water Connection Pressure Bar	0.4
Drain Connection	1.5" rubber housing
Water Connection	15mm

Shipping

Packed Weight Kg	16.5
Packed Height cm	65
Packed Width cm	32
Packed Depth cm	24

Technical Picture

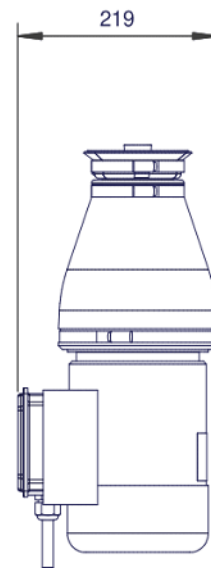
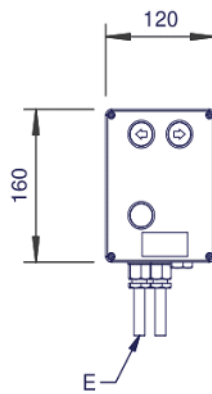
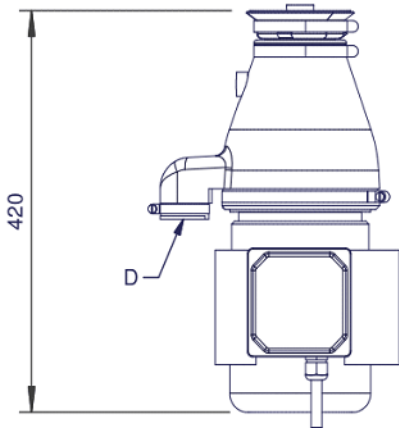
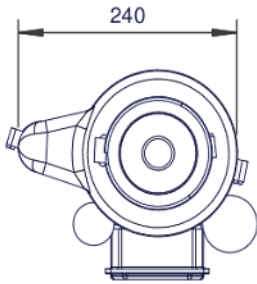



Lincat Limited

Whisby Road,
Lincoln, LN6 3QZ,
United Kingdom

Company No: 2175448

A member company of



Customer Care

Tel: +44 1522 875500
Email: care@lincat.co.uk

Export Customers

Tel: +44 1522 503250
Email: export@lincat.co.uk

Opening Hours

Monday – Friday:
8.30am – 5pm